

DENNE TEIING ER BESKYTTET VED LOV OM OPPHAVSRETT TIL ANDSVERK AV 12.05.1961 OG MÅ IKKE KOPIERES ELLER BENYTTES UTEN OPPHAVSMANNENS TILLATELSE

Fundament

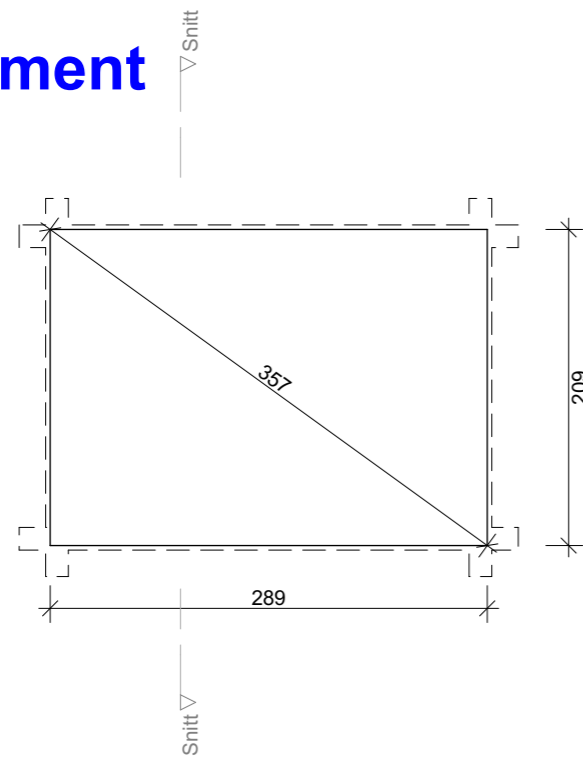

Grunnplan

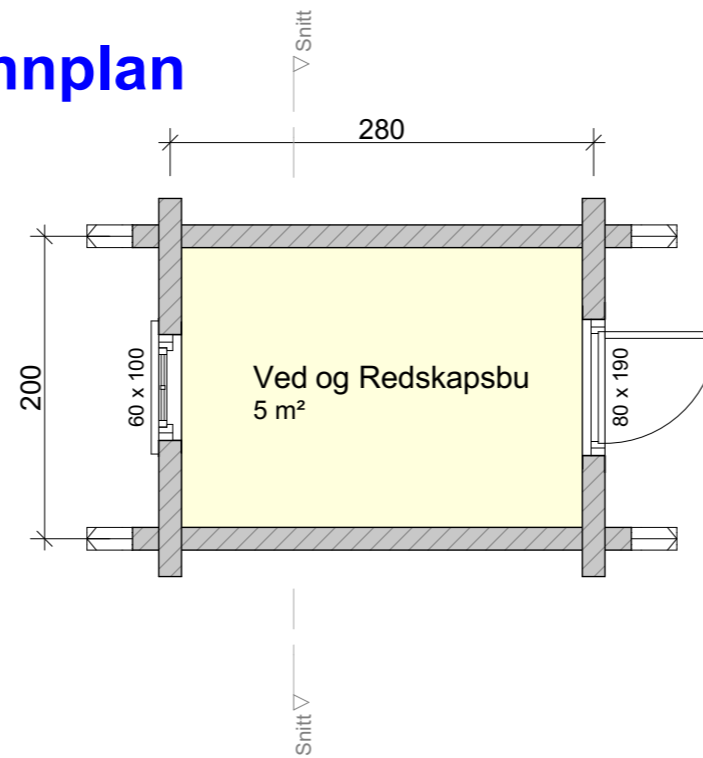

Snitt

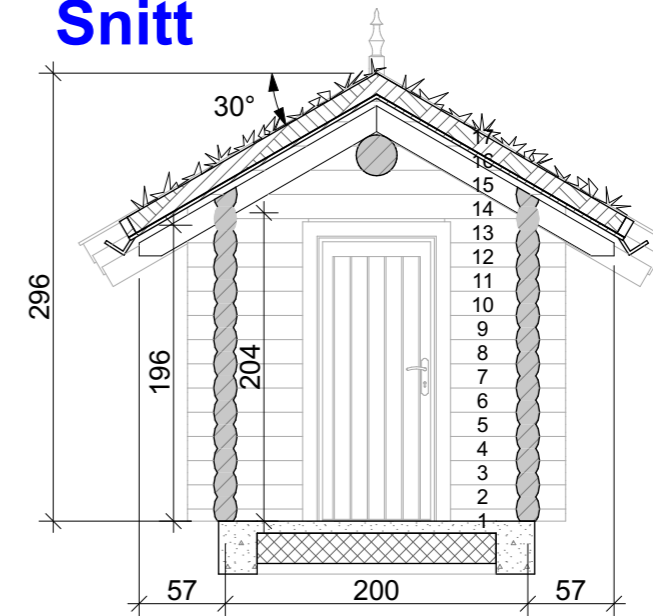

Fasade 1

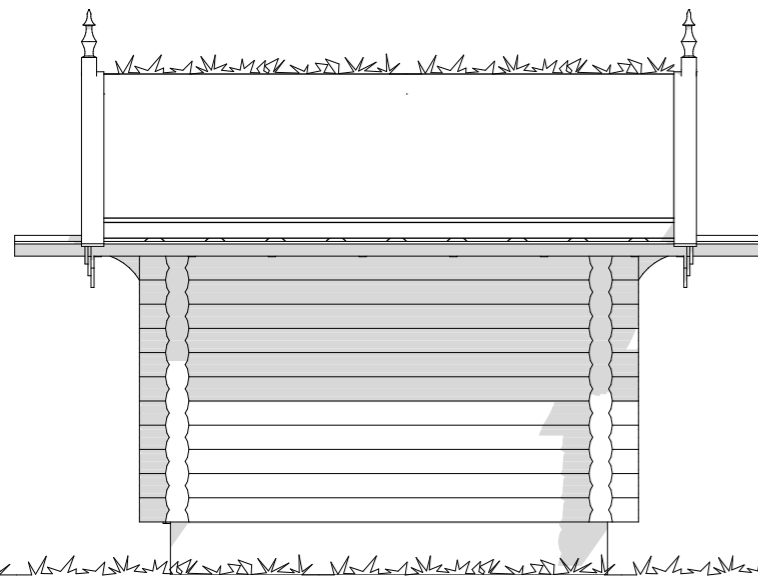

Fasade 2

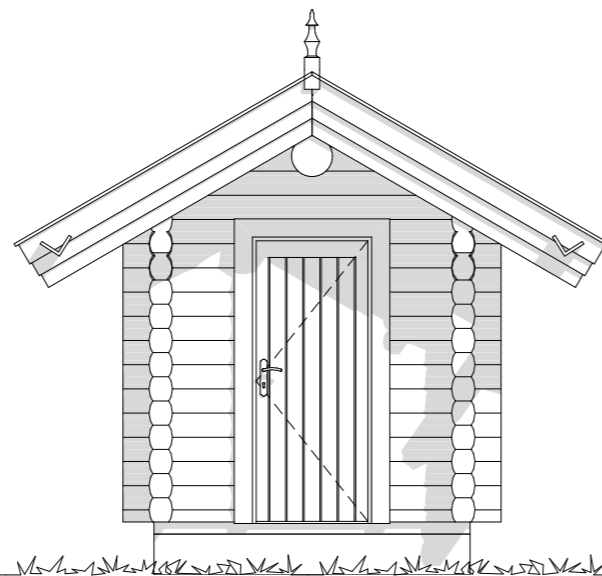

Fasade 3

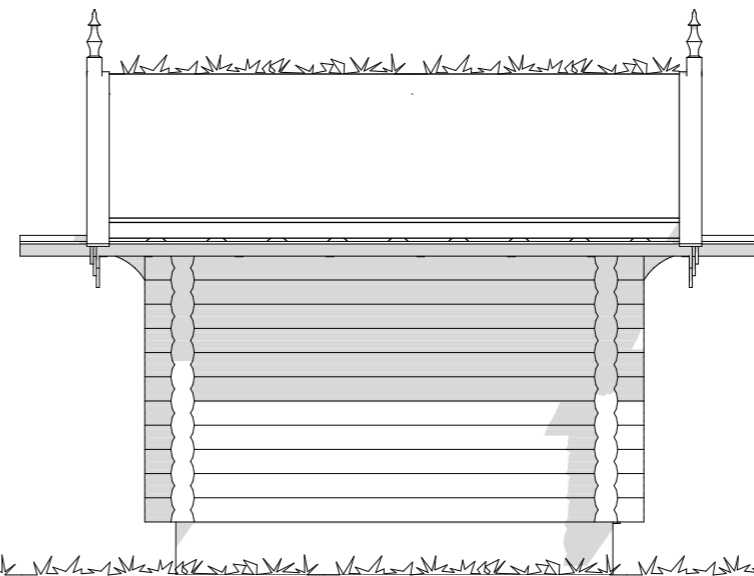

Fasade 4

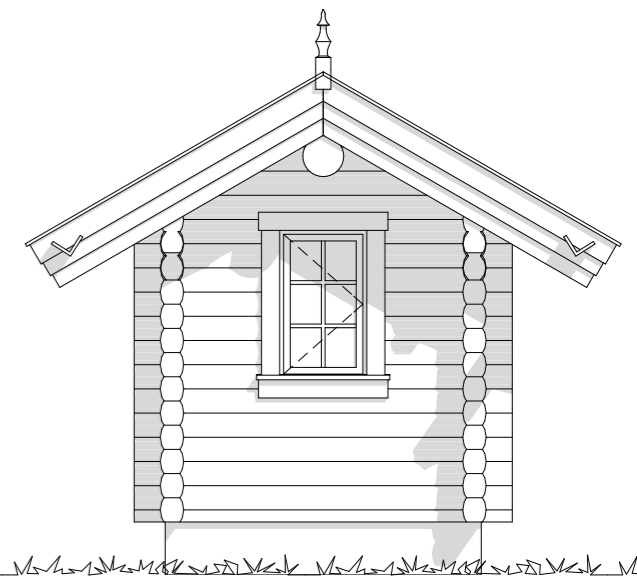

BIM-verktøy ArchCAD 18 NOR Filplassering: Q:\Hyttyper\Sporty\5.0 Ved og Redskapsbu\Prosjekt\Sporty 5.0 Ved og redskapsbu.pln

Prosjekt: Sporty 5,0 Redskaps og vedbu	Tomt: Tomt	Sted: Eiendom	Tegning: Plan, snitt og fasader	Fase: Salg	Arkitekt: Norske Fjellhus	Tegn.: B.A.Bjerke	Dato: 12.10.16	Tegn. nr.: S10-01	Rev.:
Oppdragsgiver: Norske Fjellhus as	Utarbeidet av: NORSKE FJELLHUS AS 			3620 Flesberg . Tlf. 32 76 00 93 . Fax. 32 76 02 07	Format: A3	Oppdragsnr.: Pnr	Kontr.: Aase Soleng	Målestokk: 1:50	